



Acoustical Surfaces, Inc.

SOUNDPROOFING, ACOUSTICS, NOISE & VIBRATION CONTROL SPECIALISTS

123 Columbia Court North • Suite 201 • Chaska, MN 55318
 (952) 448-5300 • Fax (952) 448-2613 • (800) 448-0121

Email: sales@acousticalsurfaces.com
 Visit our Website: www.acousticalsurfaces.com

We Identify and **S.T.O.P.** Your Noise Problems

RESILIENT SOUND ISOLATION CLIPS

For Wall & Floor Ceiling Assemblies

The Sound of Silence

RSIC-1 Resilient Sound Isolation Clip

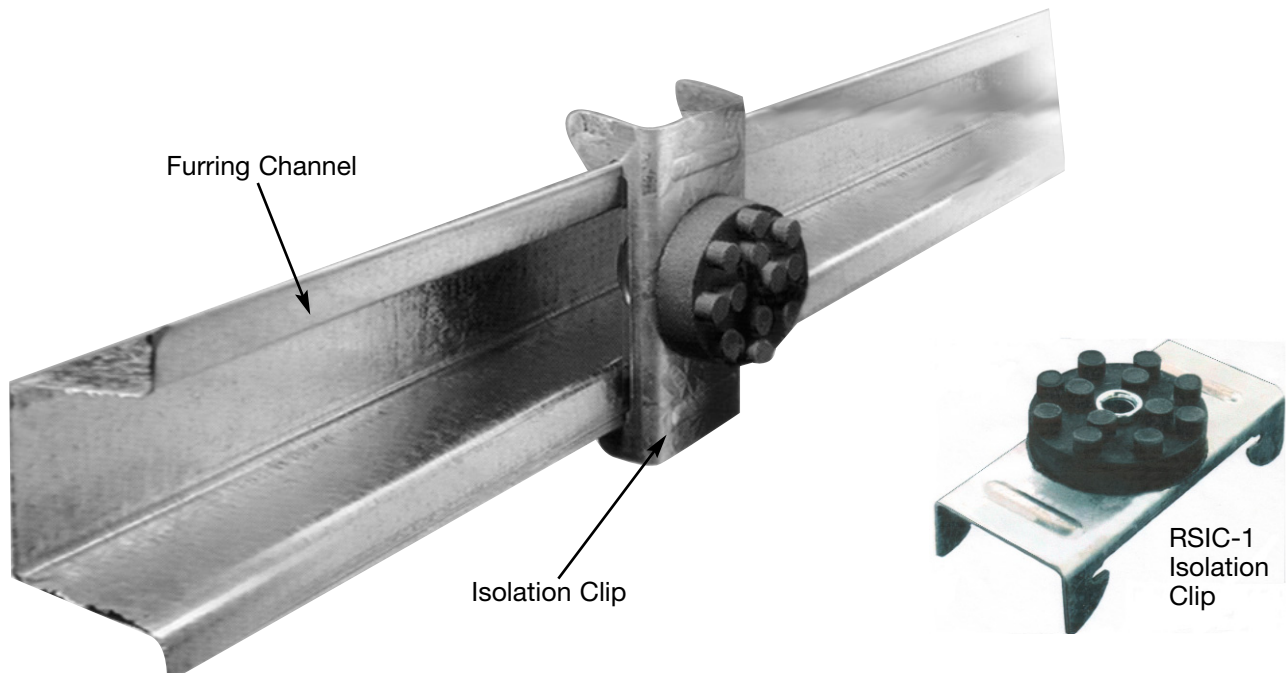

• Soundproofing Products • Sonex™ Ceiling & Wall Panels • Sound Control Curtains • Equipment Enclosures • Acoustical Baffles & Banners • Solid Wood & Veneer Acoustical Ceiling & Wall Systems • Professional Audio Acoustics • Vibration & Damping Control • Fire Retardant Acoustics • Hearing Protection • Moisture & Impact Resistant Products • Floor Impact Noise Reduction • Sound Absorbers • Noise Barriers • Fabric Wrapped Wall Panels • Acoustical Foam (Egg Crate) • Acoustical Sealants & Adhesives • Outdoor Noise Control • Assistive Listening Devices • OSHA, FDA, ADA Compliance • On-Site Acoustical Analysis • Acoustical Design & Consulting
 • Large Inventory • Fast Shipment • No Project too Large or Small • Major Credit Cards Accepted



Acoustical Surfaces, Inc.

SOUNDPROOFING, ACOUSTICS, NOISE & VIBRATION CONTROL SPECIALISTS

123 Columbia Court North • Suite 201 • Chaska, MN 55318
(952) 448-5300 • Fax (952) 448-2613 • (800) 448-0121

Email: sales@acousticalsurfaces.com
Visit our Website: www.acousticalsurfaces.com

We Identify and **S.T.O.P.** Your Noise Problems

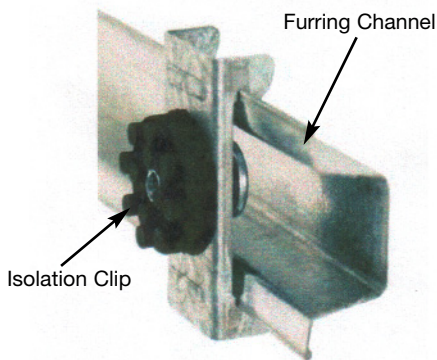
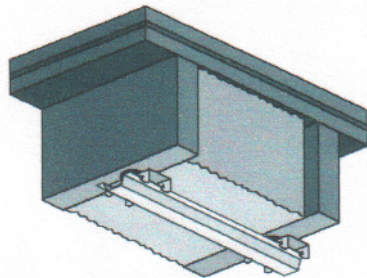
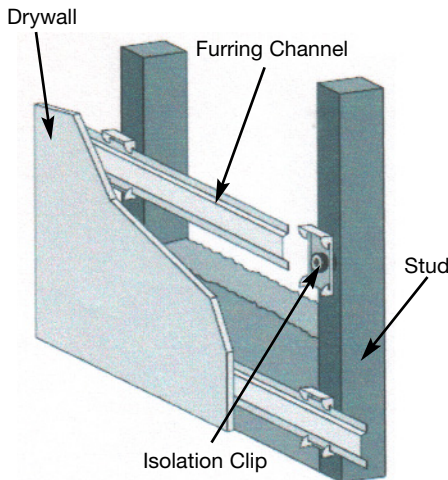

Walls: One and Two layers of 5/8" Gypsum Board

- Resilient Sound Isolation Clip (RSIC-1) shall be 48 inches maximum on center. (horizontal)
- Fasten the Resilient Sound Isolation Clip (RSIC-1) to the the substrate with a fastener approved for a minimum pull-out and shear of 120 lbs.
- Ensure the internal metal ferrell is tight to the substrate. • Locate the first row of RSIC-1 clips within 3 inches from the floor and within 6 inches from the ceiling.
- Snap in the drywall furring channel (hat track) into the RSIC-1 clips (horizontal for walls). (see page 2 for splice details).
- Place 1/4" (minimum) shim on floor to fully support the gypsum board.
- Install the gypsum board from the bottom up leaving a 1/4" min. gap around perimeter.
- ONLY remove the shims after ALL the gypsum board is completely screwed to ALL the drywall furring channels. Make sure every screw (floor to ceiling and wall to wall) is installed as required by the assembly design, in every layer of gypsum board before removing the shims at the floor. The shims are critical to ensure best results.
- Caulk around the entire perimeter of the gypsum board. Use fire and smoke rated acoustical sealant where required.

Ceilings One and Two Layers of 5/8" Gypsum Board

- Resilient Sound Isolation Clips (RSIC-1) shall be 48 inches maximum on center.
- Fasten the Resilient Sound Isolation Clip (RSIC-1) to the substrate with a fastener approved for a minimum pull-out and shear of 120 lbs.
- Ensure the internal metal ferrell is tight to the substrate.
- Locate the first row of RSIC-1 clips within 8 inches of the wall at each end of a run.
- Snap in the drywall furring channel (hat track) into the RSIC-1 clips.
- Install the gypsum board leaving a 1/4" min. gap around the gypsum board.
- Caulk around the entire perimeter of the gypsum board. Use fire and smoke rated acoustical sealant where required.

General Information:

- Refer to www.UL.com for complete installation details on all fire resistive assembly designs.
- Resilient Sound Isolation Clip (RSIC-1), furring channel (hat track) and gypsum board shall not carry heavy loads such as cabinets or bookshelves.
- Splice furring channel (hat track) with 6 inch overlap in mid span, secure with 18 ga. tie wire or with two framing screws (7/16").
- Seal all potential air leaks with non-hardening acoustical caulking to achieve best noise control results. Use fire rated sealant where required.
- When attaching the RSIC-1 clips to a steel stud the minimum allowable thickness is 20 ga. (0.030).



Acoustical Surfaces, Inc.

SOUNDPROOFING, ACOUSTICS, NOISE & VIBRATION CONTROL SPECIALISTS

123 Columbia Court North • Suite 201 • Chaska, MN 55318
(952) 448-5300 • Fax (952) 448-2613 • (800) 448-0121

Email: sales@acousticalsurfaces.com
Visit our Website: www.acousticalsurfaces.com

We Identify and **S.T.O.P.** Your Noise Problems

Drywall Furring Channel:

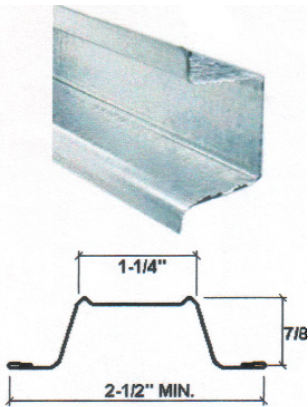

- **Minimum Requirements:** 25 gauge, hemmed edge detail required on all 25 gauge furring channel. Meets or exceeds SSMA requirements.
- **Optional:** 22 gauge (no hemmed edge required with 22 gauge).
- **Depth:** 7/8 inch.
- **Width Bottom:** 2-1/2 inch wide minimum.
- **Width Top:** 1-1/4 inch wide.

Splice drywall furring channel (hat track) with 6 inch overlap in mid-span (between two clips) secure with 18 ga tie wire, or tow 7/16" framing screws.

Resilient Sound Isolation Clip (RSIC-1):

- **Maximum Spacing:** 48 inches on center.
- **Maximum Acoustical Design Load:** 36 lbs.

Fasteners:

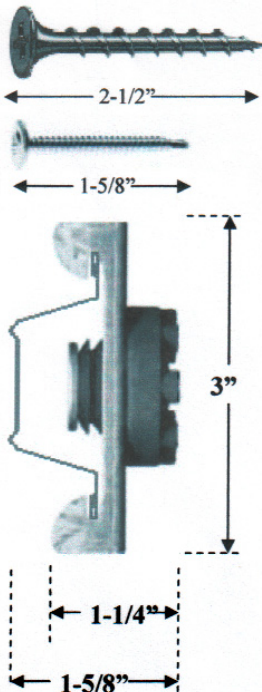

- **RSIC-1 to Wood:** #8 x 2-1/2 inch minimum size coarse thread screw. (Recommended #12 or 10 x 2-1/2 inch hex head).
- **RSIC-1 to Steel:** #8 x 1-5/8 inch minimum size fine thread screw. (Recommended #12 or #10 x 1-5/8 inch hex head).
- **DO NOT** fasten Resilient Sound Isolation Clips (RSIC-1) to framing members with nails. Use only approved screws.

RSIC-1 Dimensions:

- RSIC-1 clip 3" tall
- RSIC-1 clip 1-1/4" deep
- RSIC-1 and drywall furring channel 1-5/8" deep

Average Labor Rates:

- **RSIC-1:** 72 clips per man hour
- **Drywall Furring Channel:** 550 LF per man hour



Acoustical Surfaces, Inc.

SOUNDPROOFING, ACOUSTICS, NOISE & VIBRATION CONTROL SPECIALISTS

123 Columbia Court North • Suite 201 • Chaska, MN 55318
(952) 448-5300 • Fax (952) 448-2613 • (800) 448-0121

Email: sales@acousticalsurfaces.com
Visit our Website: www.acousticalsurfaces.com

We Identify and **S.T.O.P.** Your Noise Problems

RSIC-1 Usage Chart, DFC @ 24" on Center with RSIC-1 @ 48" o.c. Field Conditions May Effect Quantity Required

LENGTH

	1-4	5-8	9-12	13-16	17-20	21-24	25-28	29-32	33-36	37-40	41-44	45-48	49-52	53-56	57-60	61-64
W	4	6	8	10	12	14	16	18	20	22	24	26	28	30	32	34
I	6	9	12	15	18	21	24	27	30	33	36	39	42	45	48	51
D	8	12	16	20	24	28	32	36	40	44	48	52	56	60	64	68
T	10	15	20	25	30	35	40	45	50	55	60	65	70	75	80	85
H	12	18	24	30	36	42	48	54	60	66	72	78	84	90	96	102
O	14	21	28	35	42	49	56	63	70	77	84	91	98	105	112	119
R	16	24	32	40	48	56	64	72	80	88	96	104	112	120	128	136
H	18	27	36	45	54	63	72	81	90	99	108	117	126	135	144	153
E	20	30	40	50	60	70	80	90	100	110	120	130	140	150	160	170
I	22	33	44	55	66	77	88	99	110	121	132	143	154	165	176	187
G	24	36	48	60	72	84	96	108	120	132	144	156	168	180	192	204
H	26	39	52	65	78	91	104	117	130	143	156	169	182	195	208	221
T	28	42	56	70	84	98	112	126	140	154	168	182	196	210	224	238
	30	45	60	75	90	105	120	135	150	165	180	195	210	225	240	255
	32	48	64	80	96	112	128	144	160	176	192	208	224	240	256	272
	34	51	68	85	102	119	136	153	170	187	204	221	238	255	272	289
	36	54	72	90	108	126	144	162	180	198	216	234	252	270	288	306
	38	57	76	95	114	133	152	171	190	209	228	247	266	285	304	323
	40	60	80	100	120	140	160	180	200	220	240	260	280	300	320	340
	42	63	84	105	126	147	168	189	210	231	252	273	294	315	336	357
	44	66	88	110	132	154	176	198	220	242	264	286	308	330	352	374
	46	69	92	115	138	161	184	207	230	253	276	299	322	345	368	391
	48	72	96	120	144	168	192	216	240	264	288	312	336	360	384	408
	50	75	100	125	150	175	200	225	250	275	300	325	350	375	400	425
	52	78	104	130	156	182	208	234	260	286	312	338	364	390	416	442
	54	81	108	135	162	189	216	243	270	297	324	351	378	405	432	459
	56	84	112	140	168	196	224	252	280	308	336	364	392	420	448	476
	58	87	116	145	174	203	232	261	290	319	348	377	406	435	464	493
	60	90	120	150	180	210	240	270	300	330	360	390	420	450	480	510
	62	93	124	155	186	217	248	279	310	341	372	403	434	465	496	527
	64	96	128	160	192	224	256	288	320	352	384	416	448	480	512	544
	66	99	132	165	198	231	264	297	330	363	396	429	462	495	528	561
	68	102	136	170	204	238	272	306	340	374	408	442	476	510	544	578
	70	105	140	175	210	245	280	315	350	385	420	455	490	525	560	595
	72	108	144	180	216	252	288	324	360	396	432	468	504	540	576	612
	74	111	148	185	222	259	296	333	370	407	444	481	518	555	592	629
	76	114	152	190	228	266	304	342	380	418	456	494	532	570	608	646
	78	117	156	195	234	273	312	351	390	429	468	507	546	585	624	663
	80	120	160	200	240	280	320	360	400	440	480	520	560	600	640	680
	82	123	164	205	246	287	328	369	410	451	492	533	574	615	656	697

Note: Add 4 RISC-1 at each Drywall Butt Joint Condition for optimum Acoustical UL Fire Resistive Assembly compliances. See UL Fire Resistive Design Specifications.

- Soundproofing Products • Sonex™ Ceiling & Wall Panels • Sound Control Curtains • Equipment Enclosures • Acoustical Baffles & Banners • Solid Wood & Veneer Acoustical Ceiling & Wall Systems
- Professional Audio Acoustics • Vibration & Damping Control • Fire Retardant Acoustics • Hearing Protection • Moisture & Impact Resistant Products • Floor Impact Noise Reduction
- Sound Absorbers • Noise Barriers • Fabric Wrapped Wall Panels • Acoustical Foam (Egg Crate) • Acoustical Sealants & Adhesives • Outdoor Noise Control • Assistive Listening Devices
- OSHA, FDA, ADA Compliance • On-Site Acoustical Analysis • Acoustical Design & Consulting • Large Inventory • Fast Shipment • No Project too Large or Small • Major Credit Cards Accepted



Acoustical Surfaces, Inc.

SOUNDPROOFING, ACOUSTICS, NOISE & VIBRATION CONTROL SPECIALISTS

123 Columbia Court North • Suite 201 • Chaska, MN 55318
(952) 448-5300 • Fax (952) 448-2613 • (800) 448-0121

Email: sales@acousticalsurfaces.com
Visit our Website: www.acousticalsurfaces.com

We identify and **S.T.O.P.** Your Noise Problems

RSIC-1 Usage Chart, DFC @ 16" on center with RSIC-1 @ 48" o.c.

Field conditions may effect quantity required

LENGTH

	1-4	5-8	9-12	13-16	17-20	21-24	25-28	29-32	33-36	37-40	41-44	45-48	49-52	53-56	57-60	61-64
1-1.3'	4	6	8	10	12	14	16	18	20	22	24	26	28	30	32	34
1.3-2.6'	6	9	12	15	18	21	24	27	30	33	36	39	42	45	48	51
2.6-4'	8	12	16	20	24	28	32	36	40	44	48	52	56	60	64	68
4-5.3'	10	15	20	25	30	35	40	45	50	55	60	65	70	75	80	85
5.3-6.6'	12	18	24	30	36	42	48	54	60	66	72	78	84	90	96	102
6.6-8'	14	21	28	35	42	49	56	63	70	77	84	91	98	105	112	119
8-9.3'	16	24	32	40	48	56	64	72	80	88	96	104	112	120	128	136
9.3-10.6'	18	27	36	45	54	63	72	81	90	99	108	117	126	135	144	153
10.6-12'	20	30	40	50	60	70	80	90	100	110	120	130	140	150	160	170
12-13.3'	22	33	44	55	66	77	88	99	110	121	132	143	154	165	176	187
13.3-14.6'	24	36	48	60	72	84	96	108	120	132	144	156	168	180	192	204
14.6-16'	26	39	52	65	78	91	104	117	130	143	156	169	182	195	208	221
16-17.3'	28	42	56	70	84	98	112	126	140	154	168	182	196	210	224	238
17.3-18.6'	30	45	60	75	90	105	120	135	150	165	180	195	210	225	240	255
18.6-20'	32	48	64	80	96	112	128	144	160	176	192	208	224	240	256	272
20-21.3'	34	51	68	85	102	119	136	153	170	187	204	221	238	255	272	289
21.3-22.6'	36	54	72	90	108	126	144	162	180	198	216	234	252	270	288	306
22.6-24'	38	57	76	95	114	133	152	171	190	209	228	247	266	285	304	323
24-25.3'	40	60	80	100	120	140	160	180	200	220	240	260	280	300	320	340
25.3-26.6'	42	63	84	105	126	147	168	189	210	231	252	273	294	315	336	357
26.6-28'	44	66	88	110	132	154	176	198	220	242	264	286	308	330	352	374
28-29.3'	46	69	92	115	138	161	184	207	230	253	276	299	322	345	368	391
29.3-30.6	48	72	96	120	144	168	192	216	240	264	288	312	336	360	384	408
30.6-32'	50	75	100	125	150	175	200	225	250	275	300	325	350	375	400	425
32-33.3	52	78	104	130	156	182	208	234	260	286	312	338	364	390	416	442
33.3-34.6'	54	81	108	135	162	189	216	243	270	297	324	351	378	405	432	459
34.6-36'	56	84	112	140	168	196	224	252	280	308	336	364	392	420	448	476
36-37.3	58	87	116	145	174	203	232	261	290	319	348	377	406	435	464	493
38.6-40'	60	90	120	150	180	210	240	270	300	330	360	390	420	450	480	510
40-41.3'	62	93	124	155	186	217	248	279	310	341	372	403	434	465	496	527
41.3-42.6	64	96	128	160	192	224	256	288	320	352	384	416	448	480	512	544
42.6-44'	66	99	132	165	198	231	264	297	330	363	396	429	462	495	528	561
44-45.3'	68	102	136	170	204	238	272	306	340	374	408	442	476	510	544	578
45.3-46.6	70	105	140	175	210	245	280	315	350	385	420	455	490	525	560	595
48-49.3	72	108	144	180	216	252	288	324	360	396	432	468	504	540	576	612
49.3-50.6	74	111	148	185	222	259	296	333	370	407	444	481	518	555	592	629
50.6-52'	76	114	152	190	228	266	304	342	380	418	456	494	532	570	608	646
52-53.3'	78	117	156	195	234	273	312	351	390	429	468	507	546	585	624	663
53.3-54.6	80	120	160	200	240	280	320	360	400	440	480	520	560	600	640	680
54.6-56'	82	123	164	205	246	287	328	369	410	451	492	533	574	615	656	697

Note: Add 4 RISC-1 at each Drywall Butt Joint Condition for Optimum Acoustical UL Fire Resistant Assembly Compliances. See UL Fire Resistant Design Specifications.

- Soundproofing Products • Sonex™ Ceiling & Wall Panels • Sound Control Curtains • Equipment Enclosures • Acoustical Baffles & Banners • Solid Wood & Veneer Acoustical Ceiling & Wall Systems
- Professional Audio Acoustics • Vibration & Damping Control • Fire Retardant Acoustics • Hearing Protection • Moisture & Impact Resistant Products • Floor Impact Noise Reduction
- Sound Absorbers • Noise Barriers • Fabric Wrapped Wall Panels • Acoustical Foam (Egg Crate) • Acoustical Sealants & Adhesives • Outdoor Noise Control • Assistive Listening Devices
- OSHA, FDA, ADA Compliance • On-Site Acoustical Analysis • Acoustical Design & Consulting • Large Inventory • Fast Shipment • No Project too Large or Small • Major Credit Cards Accepted



Acoustical Surfaces, Inc.

SOUNDPROOFING, ACOUSTICS, NOISE & VIBRATION CONTROL SPECIALISTS

123 Columbia Court North • Suite 201 • Chaska, MN 55318
 (952) 448-5300 • Fax (952) 448-2613 • (800) 448-0121

Email: sales@acousticalsurfaces.com
 Visit our Website: www.acousticalsurfaces.com

We Identify and **S.T.O.P.** Your Noise Problems

Estimated RSIC Clip Usage for Walls and Ceilings, Wood or Steel Framed. (Spacing at 24" x 48" O.C.)

	1-4	5-8	9-12	13-16	17-20	21-24	25-28	29-32	33-36	37-40
1-3'	4	6	8	10	12	14	16	18	20	22
3-5	6	9	12	15	18	21	24	27	30	33
5-7	8	12	16	20	24	28	32	36	40	44
7-9	10	15	20	25	30	35	40	45	50	55
9-11	12	18	24	30	36	42	48	54	60	66
11-13	14	21	28	35	42	49	56	63	70	77
13-15	16	24	32	40	48	56	64	72	80	88
15-17	18	27	36	45	54	63	72	81	90	99
17-19	20	30	40	50	60	70	80	90	100	110
19-21	22	33	44	55	66	77	88	99	110	121
21-23	24	36	48	60	72	84	96	108	120	132
23-25	26	39	52	65	78	91	104	117	130	143
25-27	28	42	56	70	84	98	112	126	140	154
27-29	30	45	60	75	90	105	120	135	150	165
29-31	32	48	64	80	96	112	128	144	160	176
31-33	34	51	68	85	102	119	136	153	170	187
33-35	36	54	72	90	108	126	144	162	180	198
35-37	38	57	76	95	114	133	152	171	190	209
37-39	40	60	80	100	120	140	160	180	200	220
39-41	42	63	84	105	126	147	168	189	210	231

Note: Add 4 RISC-1 at each Drywall Butt Joint Condition for Optimum Acoustical UL Fire Resistive Assembly Compliances.
 See UL Fire Resistive Design Specifications.



Acoustical Surfaces, Inc.

SOUNDPROOFING, ACOUSTICS, NOISE & VIBRATION CONTROL SPECIALISTS

123 Columbia Court North • Suite 201 • Chaska, MN 55318
 (952) 448-5300 • Fax (952) 448-2613 • (800) 448-0121

Email: sales@acousticalsurfaces.com
 Visit our Website: www.acousticalsurfaces.com

We Identify and **S.T.O.P.** Your Noise Problems

Estimated RSIC Clip Usage for Walls and Ceilings, Wood or Steel Framed. (Spacing at 16" x 48" O.C.)

	1-4	5-8	9-12	13-16	17-20	21-24	25-28	29-32	33-36	37-40
1-1.3'	4	6	8	10	12	14	16	18	20	22
1.3-2.6'	6	9	12	15	18	21	24	27	30	33
2.6-4'	8	12	16	20	24	28	32	36	40	44
4-5.3'	10	15	20	25	30	35	40	45	50	55
5.3-6.6'	12	18	24	30	36	42	48	54	60	66
6.6-8'	14	21	28	35	42	49	56	63	70	77
8-9.3'	16	24	32	40	48	56	64	72	80	88
9.3-10.6'	18	27	36	45	54	63	72	81	90	99
10.6-12'	20	30	40	50	60	70	80	90	100	110
12-13.3'	22	33	44	55	66	77	88	99	110	121
13.3-14.6'	24	36	48	60	72	84	96	108	120	132
14.6-16'	26	39	52	65	78	91	104	117	130	143
16-17.3'	28	42	56	70	84	98	112	126	140	154
17.3-18.6'	30	45	60	75	90	105	120	135	150	165
18.6-20'	32	48	64	80	96	112	128	144	160	176
20-21.3'	34	51	68	85	102	119	136	153	170	187
21.3-22.6'	36	54	72	90	108	126	144	162	180	198
22.6-24'	38	57	76	95	114	133	152	171	190	209
24-25.3'	40	60	80	100	120	140	160	180	200	220
25.3-26.6'	42	63	84	105	126	147	168	189	210	231
26.6-28'	44	66	88	110	132	154	176	198	220	242
28-29.3'	46	69	92	115	138	161	184	207	230	253
29.3-30.6'	48	72	96	120	144	168	192	216	240	264
30.6-32'	50	75	100	125	150	175	200	225	250	275
32-33.3'	52	78	104	130	156	182	208	234	260	286
33.3-34.6'	54	81	108	135	162	189	216	243	270	297
34.6-36'	56	84	112	140	168	196	224	252	280	308
36-37.3'	58	87	116	145	174	203	232	261	290	319
38.6-40'	60	90	120	150	180	210	240	270	300	330
40-41.3'	62	93	124	155	186	217	248	279	310	341

Note: Add 4 RISC-1 at each Drywall Butt Joint Condition for Optimum Acoustical UL Fire Resistive Assembly Compliances. See UL Fire Resistive Design Specifications.



Acoustical Surfaces, Inc.

SOUNDPROOFING, ACOUSTICS, NOISE & VIBRATION CONTROL SPECIALISTS

123 Columbia Court North • Suite 201 • Chaska, MN 55318
 (952) 448-5300 • Fax (952) 448-2613 • (800) 448-0121

Email: sales@acousticalsurfaces.com
 Visit our Website: www.acousticalsurfaces.com

We Identify and **S.T.O.P.** Your Noise Problems

Application Recommendations for Walls and Ceilings, Wood or Steel Framing

INSTALLING RESILIENT SOUND ISOLATION CLIPS (RSIC-1)

RSIC CLIPS AT 16" O.C.

RSIC-1 Wall or Ceiling System Framing at 24" o.c.

RSIC-1 clips at 16" x 48" o.c. 3 Layers of 5/8" Gypsum Board

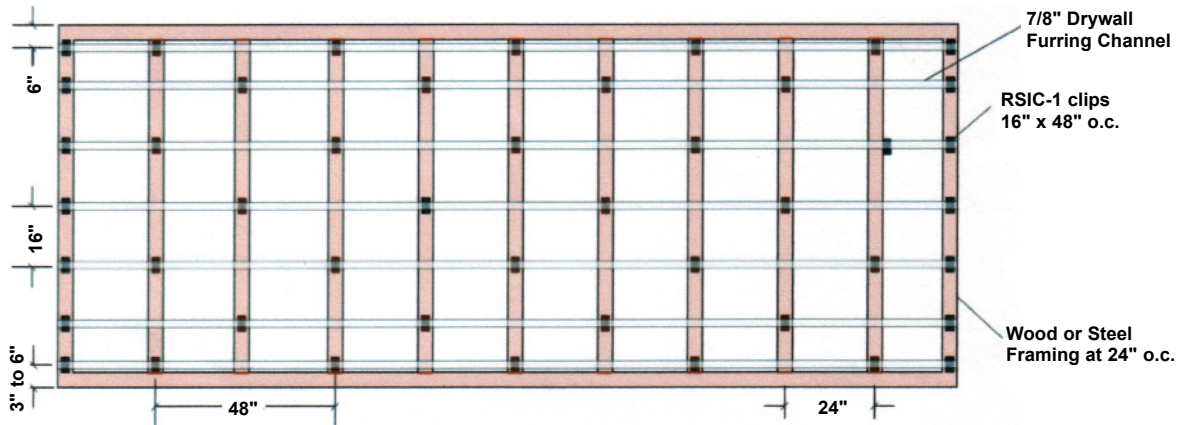

RSIC-1 Wall or Ceiling System Framing at 16" o.c.

RSIC-1 clips at 16" x 48" o.c. 3 Layers of 5/8" Gypsum Board

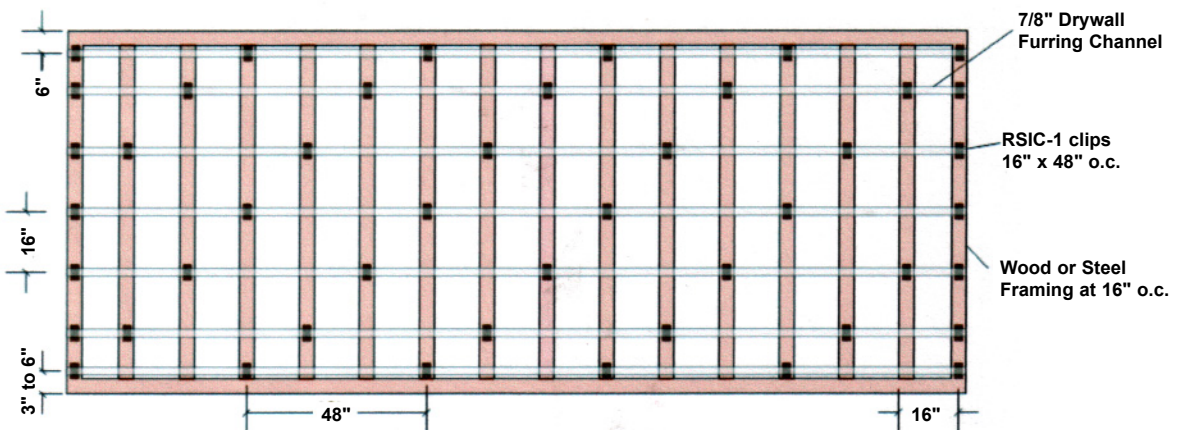



Acoustical Surfaces, Inc.

SOUNDPROOFING, ACOUSTICS, NOISE & VIBRATION CONTROL SPECIALISTS

123 Columbia Court North • Suite 201 • Chaska, MN 55318
 (952) 448-5300 • Fax (952) 448-2613 • (800) 448-0121

Email: sales@acousticalsurfaces.com
 Visit our Website: www.acousticalsurfaces.com

We Identify and **S.T.O.P.** Your Noise Problems

Application Recommendations for Walls and Ceilings, Wood or Steel Framing

INSTALLING RESILIENT SOUND ISOLATION CLIPS (RSIC-1)

RSIC CLIPS AT 24" O.C.

RSIC-1 Wall or Ceiling System Framing at 24" o.c.

RSIC-1 clips at 24" x 48" o.c. 1 or 2 Layers of 5/8" Gypsum Board

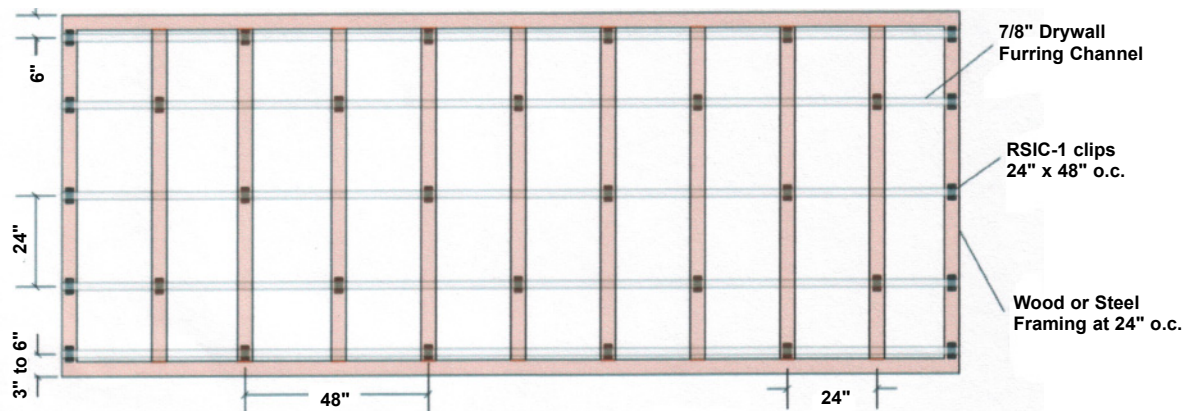

RSIC-1 Wall or Ceiling System Framing at 16" o.c.

RSIC-1 clips at 24" x 48" o.c. 1 or 2 Layers of 5/8" Gypsum Board

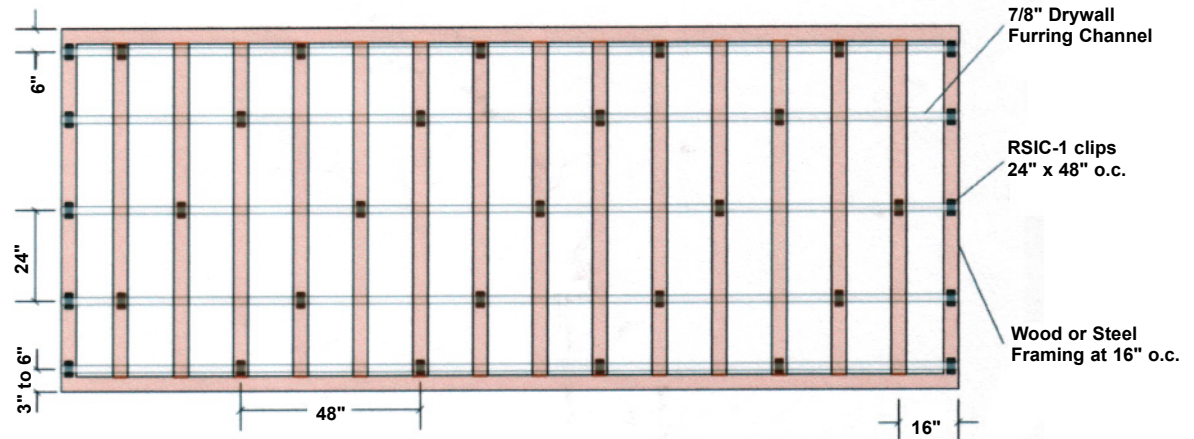



Acoustical Surfaces, Inc.

Soundproofing, Acoustics, Noise & Vibration Control Specialists

123 Columbia Court North • Suite 201 • Chaska, MN 55318
(952) 448-5300 • Fax (952) 448-2613 • (800) 448-0121

Email: sales@acousticalsurfaces.com
Visit our Website: www.acousticalsurfaces.com

We Identify and **S.T.O.P.** Your Noise Problems

The Noise S.T.O.P.™ RSIC-1 Resilient Sound Isolation Clip

RSIC-1 Wall Assemblies vs. Generic Wall Assemblies

The RSIC-1 wall systems give you a higher performing wall, while saving you money and reducing the wall thickness. The RSIC-1 wall systems are the highest performing wall systems per dollar spent.

RSIC-1 Wood Wall Assemblies 1 & 2 Hour:

2x4 stud wall, RSIC-1, Drywall furring channel, R-19 insulation,
2 layers one side, 3 layers other side 5/8" gypsum board.

STC 63

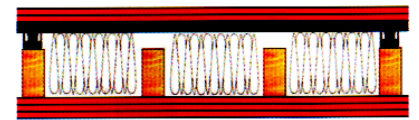

UL U301, U 305, U309, U311, U331, U334

2x4 stud wall, RSIC-1, Drywall furring channel, R-19 insulation, 2 layers
5/8" gypsum board, each side

STC 62



UL U301, U305 U309 U311 U331 U334

2x4 stud wall, RSIC-1, Drywall furring channel, R-19 insulation, 1 layer
5/8" gypsum board, 2 layers 5/8" gypsum board

STC 60



UL 305 U309 U311 U331

2 x 4 stud wall, RSIC-1, Drywall furring channel, 3.5" insulation,
1 layer 5/8" gypsum board each side

STC 56



UL U305 U309 U311 U331

GENERIC WOOD WALL SYSTEM

2x4 double stud wall, 3.5" insulation, 2 layers 5/8" gypsum board each
side

STC 59



2x4 double stud wall, 3.5" insulation, 1 layer 5/8" gypsum board each
side

STC 56

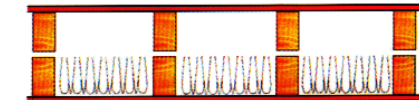

2x4 stagger stud wall, RC-1 channel, 3.5" insulation, 1 layer 5/8" gypsum
board each side

STC 51

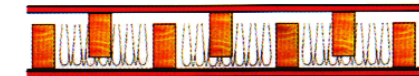

2x4 stagger stud wall, 3.5" insulation, 1 layer 5/8" gypsum board each
side

STC 47



2x4 stud wall, RC-1 channel, 3.5" insulation, 1 layer 5/8" gypsum board
each side

STC 46

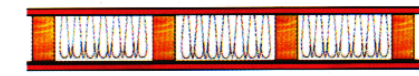

2x4 stud wall, 3.5" insulation, 1 layer 5/8" gypsum board each side

STC 36

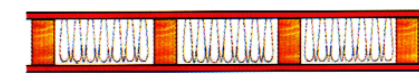

• Soundproofing Products • Sonex™ Ceiling & Wall Panels • Sound Control Curtains • Equipment Enclosures • Acoustical Baffles & Banners • Solid Wood & Veneer
Acoustical Ceiling & Wall Systems • Professional Audio Acoustics • Vibration & Damping Control • Fire Retardant Acoustics • Hearing Protection • Moisture & Impact
Resistant Products • Floor Impact Noise Reduction • Sound Absorbers • Noise Barriers • Fabric Wrapped Wall Panels • Acoustical Foam (Egg Crate) • Acoustical Sealants
& Adhesives • Outdoor Noise Control • Assistive Listening Devices • OSHA, FDA, ADA Compliance • On-Site Acoustical Analysis • Acoustical Design & Consulting
• Large Inventory • Fast Shipment • No Project too Large or Small • Major Credit Cards Accepted



Acoustical Surfaces, Inc.

Soundproofing, Acoustics, Noise & Vibration Control Specialists

123 Columbia Court North • Suite 201 • Chaska, MN 55318
(952) 448-5300 • Fax (952) 448-2613 • (800) 448-0121

Email: sales@acousticalsurfaces.com
Visit our Website: www.acousticalsurfaces.com

We Identify and **S.T.O.P.** Your Noise Problems

The Noise S.T.O.P.™ RSIC-1 Resilient Sound Isolation Clip

RSIC-1 STEEL WALL ASSEMBLIES 1 & 2 HOUR:

3-5/8" steel stud wall, RSIC-1, drywall furring channel, R-19 insulation,
2 layers 5/8" board RSIC-1 side, 3 layers other side 5/8" board

UL U419, U423

STC 63



3-5/8" steel stud wall, RSIC-1, Drywall furring channel, R-19 insulation,
2 layers 5/8" board each side

UL U419, U423

STC 62



3-5/8" steel stud wall, RSIC-1, Drywall furring channel, R-19 insulation,
1 layer 5/8" board RSIC side, 2 layers 5/8" gypsum board other side

UL U419, U423

STC 60



3-5/8" steel stud wall, RSIC-1, Drywall furring channel, R-19 insulation,
1 layer 5/8" board each side

UL U419, U423

STC 56



GENERIC STEEL WALL SYSTEMS:

3-5/8" double steel stud wall, R-11 insulation,
2 layers 5/8" gypsum board each side

STC 59

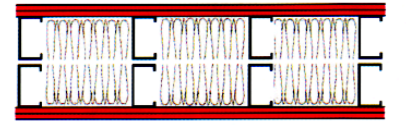

3-5/8" double steel stud wall, R-11 insulation,
1 layer 1 5/8" gypsum each side

STC 56

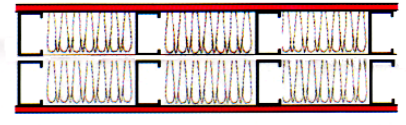

3-5/8" steel stud wall, R-11 insulation,
2 layers 5/8" gypsum each side

STC 51



3-5/8" steel stud wall, R-11 insulation,
1 layer 1 5/8" gypsum each side

STC 46

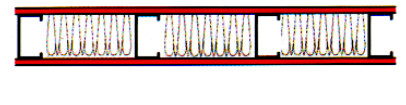

RSIC-1 WALL

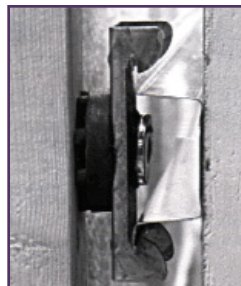



Acoustical Surfaces, Inc.

Soundproofing, Acoustics, Noise & Vibration Control Specialists

123 Columbia Court North • Suite 201 • Chaska, MN 55318
(952) 448-5300 • Fax (952) 448-2613 • (800) 448-0121

Email: sales@acousticalsurfaces.com

Visit our Website: www.acousticalsurfaces.com

We Identify and **S.T.O.P.** Your Noise Problems

The Noise S.T.O.P.™ RSIC-1 Resilient Sound Isolation Clip

RSIC-1 WOOD FLOOR CEILING ASSEMBLIES 1 & 2 HOUR:

UL L528, L542, L532, L523, L514, L513

Carpet	STC 61	IIC 74
Hard Wood	STC 61	IIC 55
Tile	STC 61	IIC 53

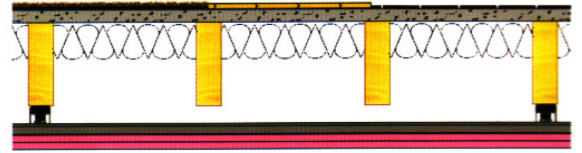

UL L547 L518

Carpet	STC 61	IIC 74
Hard Wood	STC 61	IIC 55
Tile	STC 61	IIC 53
FIIC test with tile floor FIIC 63		

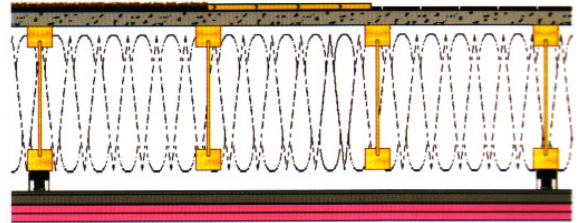

RSIC-1 STEEL FLOOR CEILING ASSEMBLIES 1 & 2 HOUR:

UL L518

Carpet	STC 60	IIC 70
Hard Wood	STC 60	IIC 53
Tile	STC 60	IIC 50

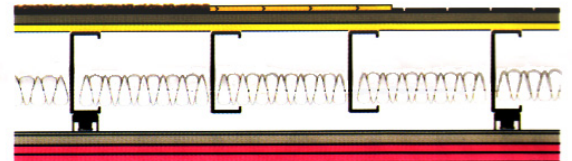

RSIC-1 CONCRETE FLOOR CEILING ASSEMBLIES 1 & 2 HOUR:

UL L945

Carpet	STC 60	IIC 84
Hard Wood	STC 60	IIC 74
Tile	STC 60	IIC 70
Bare	STC 60	IIC 51

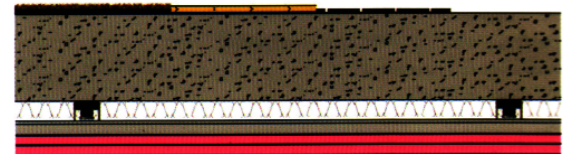

RSIC-1 CEILING





Acoustical Surfaces, Inc.

Soundproofing, Acoustics, Noise & Vibration Control Specialists

123 Columbia Court North • Suite 201 • Chaska, MN 55318
 (952) 448-5300 • Fax (952) 448-2613 • (800) 448-0121

Email: sales@acousticalsurfaces.com
 Visit our Website: www.acousticalsurfaces.com

We Identify and **S.T.O.P.** Your Noise Problems

The Noise S.T.O.P.™ RSIC-1 Resilient Sound Isolation Clip

The RSIC-1 Wall Systems



THE RSIC-1 Floor/Ceiling System

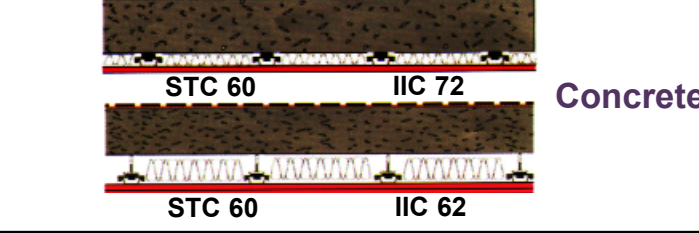
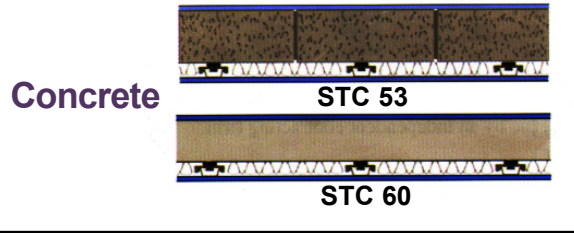
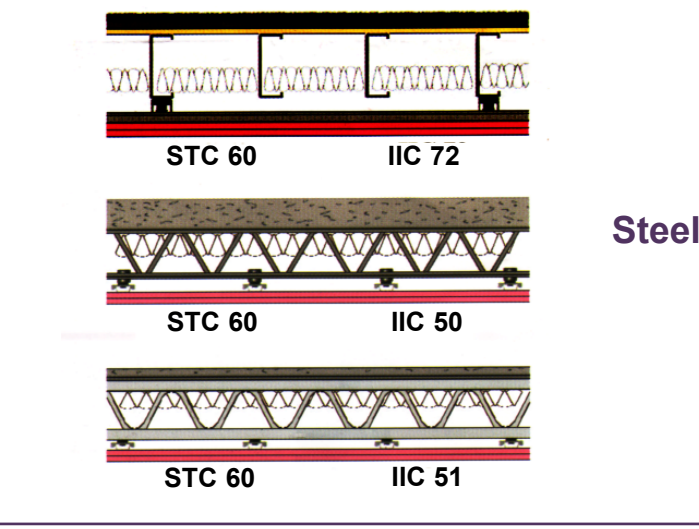
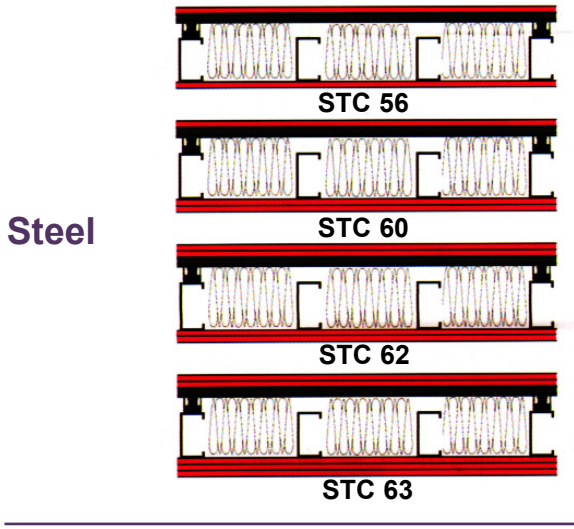
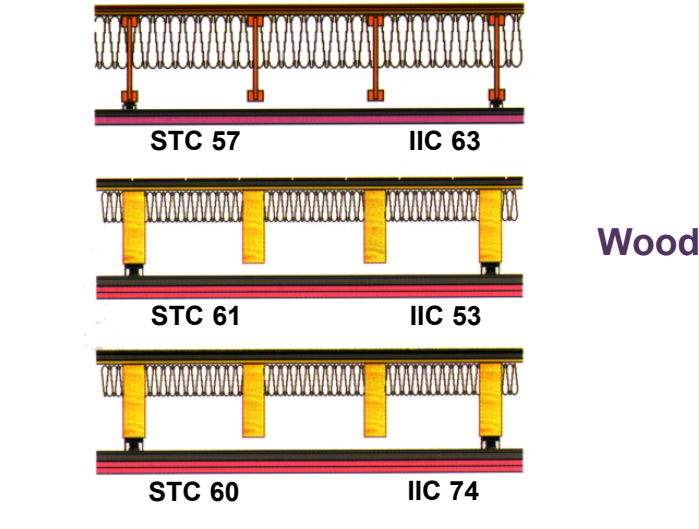

• Soundproofing Products • Sonex™ Ceiling & Wall Panels • Sound Control Curtains • Equipment Enclosures • Acoustical Baffles & Banners • Solid Wood & Veneer Acoustical Ceiling & Wall Systems • Professional Audio Acoustics • Vibration & Damping Control • Fire Retardant Acoustics • Hearing Protection • Moisture & Impact Resistant Products • Floor Impact Noise Reduction • Sound Absorbers • Noise Barriers • Fabric Wrapped Wall Panels • Acoustical Foam (Egg Crate) • Acoustical Sealants & Adhesives • Outdoor Noise Control • Assistive Listening Devices • OSHA, FDA, ADA Compliance • On-Site Acoustical Analysis • Acoustical Design & Consulting • Large Inventory • Fast Shipment • No Project too Large or Small • Major Credit Cards Accepted



Acoustical Surfaces, Inc.

Soundproofing, Acoustics, Noise & Vibration Control Specialists

123 Columbia Court North • Suite 201 • Chaska, MN 55318
 (952) 448-5300 • Fax (952) 448-2613 • (800) 448-0121

Email: sales@acousticalsurfaces.com
 Visit our Website: www.acousticalsurfaces.com

We Identify and **S.T.O.P.** Your Noise Problems

The Noise S.T.O.P.™ RSIC-1 Resilient Sound Isolation Clip



“Field Impact Isolation Class” (FIIC) 63

CONSTRUCTION:

- Ceramic tile
- 1-1/4" lt. wt. Gypsum Concrete
- 1/4" acoustical mat
- 1-1/8" T & G plywood deck
- 22" deep "1" beam
- Cellulose insulation RSIC-1
- Drywall Furring Channel
- 2 layers 5/8" gypsum board

FIIC	FSTC
Impact Insulation Class	Sound Transmission Class
FIIC 63	FSTC 57

The Sound of Silence

- Sound Transmission Class (STC) rating of 56, a full 19 STC pts greater than similar wall assemblies without RSIC-1. (RAL Report 208)
- Experience with the RSIC-1 has recorded remarkable improvements of up to an additional 20 STC pts on walls.
- Not only is the RSIC-1 silencing the competition with noise elimination, the RSIC-1 is approved for UL Classification in over 140 Fire Resistive Design Assemblies. Up to 4 (four) hour Rated Systems.
- **Quiet and safe what a nice combination**

TEST	STC
Report No. TL-01-208	56
Report No. TL-01-209	56
Report No. TL-01-210	60
Report No. TL-01-211	62
Report No. TL-01-212	63

2-1/2" screw x #8 course thread screw (minimum 1-1/2" penetration on wood framing numbers).

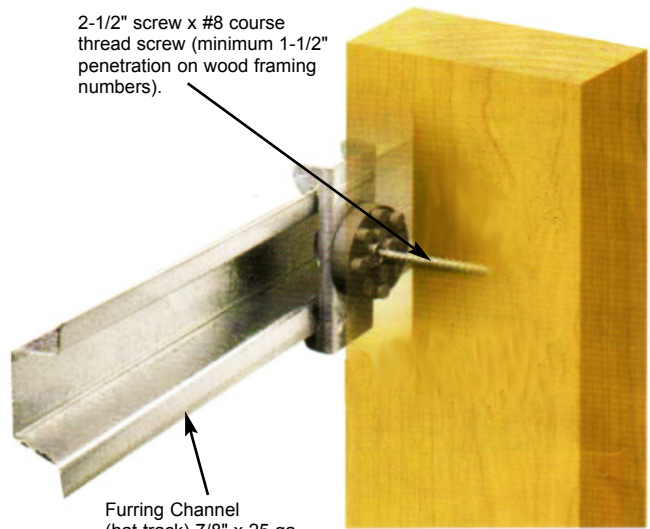

Furring Channel (hat track) 7/8" x 25 ga. (18 mil) galvanized, hemmed edge.